

HAND-HELD DEVICES

Software Configuration Manual

HAND-HELD DEVICES
SOFTWARE CONFIGURATION MANUAL

This manual refers to
software version 4.00

Datalogic reserves the right to make modifications and improvements without prior notification.

Product names mentioned herein are for identification purposes only and may be trademarks and or registered trademarks of their respective companies.

© - 1999 Datalogic S.p.A.

(Rev. A)

CONTENTS

	How To Use This Manual	v
1	INTRODUCTION	1
1.1	Status Indicators	2
2	CONFIGURATION	3
	RS232 Parameters.....	4
	Wedge Parameters	10
	Pen Emulation Parameters	13
	Data Format Parameters.....	17
	Power Save Parameters	21
	Reading Parameters	24
	Decoding Parameters	30
	Code Selection Parameters	33
3	REFERENCES	44
3.1	RS232 Parameters.....	44
3.1.1	Handshaking	44
3.1.2	ACK/NACK Protocol.....	45
3.1.3	FIFO	45
3.1.4	RX Timeout	45
3.2	Pen Emulation Parameters	46
3.2.1	Minimum Output Pulse.....	46
3.2.2	Overflow	46
3.2.3	Output and Idle Levels	46
3.3	Data Format	48
3.3.1	Header/Terminator Selection	48
3.4	Power Save.....	49
3.4.1	Illuminator/Laser Driver	49
3.4.2	Sleep State.....	49
3.4.3	Enter Sleep State	49
3.4.4	Standby	49
3.5	Reading Parameters	50
3.5.1	Trigger Signal.....	50
3.5.2	Trigger-Off Timeout.....	50

3.5.3	Reads per Cycle.....	50
3.5.4	Safety Time	51
3.6	Decoding Parameters	51
3.6.1	Ink-Spread.....	51
3.6.2	Overflow Control	52
3.6.3	Interdigit Control.....	52
3.7	Configuration Editing Commands	52
4	TROUBLESHOOTING.....	54
A	HOST CONFIGURATION STRINGS.....	A.1
B	CODE IDENTIFIER TABLE.....	B.1
C	HEX AND NUMERIC TABLES.....	C.1

HOW TO USE THIS MANUAL

All HHD products are supplied with their own Quick Reference Manual which provides connection diagrams, reading diagrams, basic application parameter settings, default values, and specific technical features.

Use your device's Quick Reference Manual for initial configuration in order to set the default values and select the interface for your application.

If you wish to change the default settings, this manual provides complete configuration of your Hand-Held Device in an easy way.

- **To configure your device:**

- 1) Open the folded page in Appendix C with the hex-numeric table and keep it open during the device configuration.
- 2) Read the **Enter Configuration** code ONCE, available at the top of each page in chapter 2.
- 3) Modify the desired parameters in one or more sections following the procedures given for each group.
- 4) Read the **Exit and Save Configuration** code ONCE, available at the top of each page in chapter 2.

Reference notes describing the operation of the more complex parameters are given in chapter 3.

An alternative configuration method is provided in Appendix A using the RS232 interface. This method is particularly useful when many devices need to be configured with the same settings. Batch files containing the desired parameter settings can be prepared to configure devices quickly and easily.

Device configuration can also be performed using the **WinSET** Windows-based utility program available from your local Datalogic distributor. This method provides direct RS232 interface configuration as well as configuration barcode printing.

This page is intentionally left blank.

1 INTRODUCTION

This manual provides all the necessary information for complete software configuration of various Datalogic families of **Hand-Held Devices** including CCD guns and readers, laser scanners, and decoders.

These HHD products contain a built-in decoder and multi-standard interface.

They are designed for use in a wide variety of applications and environments including **commercial**, **office automation**, **retail**, and **industrial** applications where large quantities of information need to be collected rapidly, easily and reliably.

These families of HHD products have common status indicator functions which are described in the next paragraph.

1.1 STATUS INDICATORS

The HHD readers have two indicators, LED and beeper. They signal several operating conditions which are described in the tables below.

POWER UP

Beeper	Meaning
L L L L	Parameters loaded correctly
H H H H long tones	Parameter loading error, reading or writing error in the non volatile memory
H L H L	Hardware error in EEPROM

CONFIGURATION

Beeper	Meaning
H H H H	correct entry or exit from Configuration mode
L	good read of a command
L L L	command read error

DATA ENTRY

LED	Beeper	Meaning
ON	one beep [°]	correct read of a code in normal mode
OFF		ready to read a code
	H L H L	output interface not selected or reader type not selected (see the Quick Reference Manual)
	H L long tones	tx buffer full

H = high tone **L** = low tone

[°] (user configurable)

2 CONFIGURATION

Use your device's Quick Reference Manual for initial configuration in order to set the default values and select the interface for your application.

In this manual, the configuration parameters are divided into logical groups making it easy to find the desired function based on its reference group.

The first three groups are for Standard Interface parameter configuration:

- **RS232**
- **WEDGE**
- **PEN EMULATION**

If you are using a device that supports an interface selection other than the ones listed above, refer to the Quick Reference manual of the device for specific interface configuration parameters.

The following groups apply to all HHD products:

DATA FORMAT parameters regard the messages sent to the Host system for all interfaces except Pen Emulation.

POWER SAVE manages overall current consumption in the reading device.

READING PARAMETERS control various operating modes and indicator status functioning.

DECODING PARAMETERS maintain correct barcode decoding in certain special reading conditions.

CODE SELECTION parameters allow configuration of a personalized mix of codes, code families and their options.

RS232 PARAMETERS

PARAMETERS

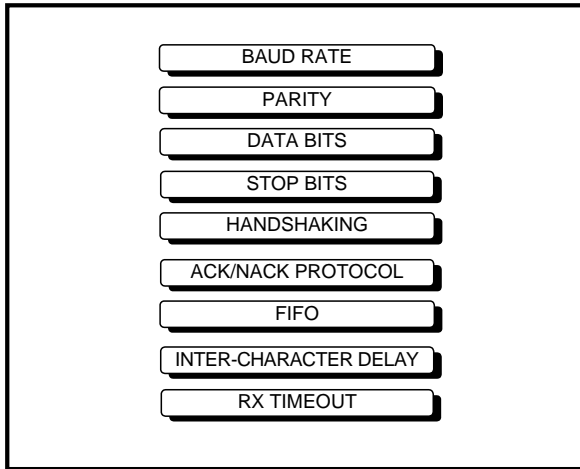

1. Read the **Enter Configuration** code ONCE, available at the top of each page.
2. Read configuration codes from the desired groups.



= Read the code and follow the procedure given

3. Read the **Exit and Save Configuration** code ONCE, available at the top of each page.



RS232



BAUD RATE

150 baud

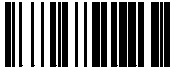

2400 baud



300 baud



4800 baud



600 baud



9600 baud



1200 baud



19200 baud





RS232



PARITY

none



even parity



odd parity



DATA BITS

7 bits

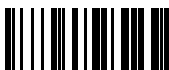

8 bits

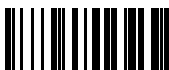

9 bits





STOP BITS

1 stop bit



2 stop bits



HANDSHAKING

disable



hardware (RTS/CTS)



software (XON/XOFF)



See par. 3.1.1 for details.



ACK/NACK PROTOCOL

enable



disable



See par. 3.1.2 for details.

FIFO

enable



disable



See par. 3.1.3 for details.



INTER-CHARACTER DELAY



delay between characters transmitted to Host



Read 2 numbers from the table where:

- 00 = DELAY disabled
- 01-99 = DELAY from **1** to **99** milliseconds

RX TIMEOUT



timeout control in reception from Host



Read 2 numbers from the table where:

- 00 = TIMEOUT disabled
- 01-99 = TIMEOUT from **.1** to **9.9** seconds

See par. 3.1.4 for details.

WEDGE PARAMETERS

PARAMETERS

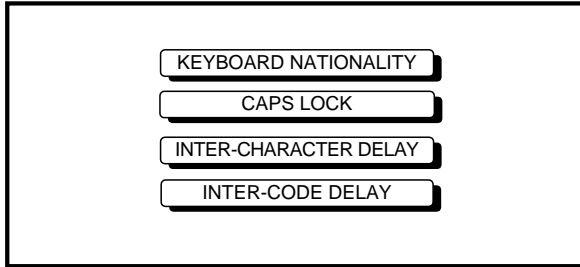

1. Read the **Enter Configuration** code ONCE, available at the top of each page.

2. Read configuration codes from the desired groups.



= Read the code and follow the procedure given

3. Read the **Exit and Save Configuration** code ONCE, available at the top of each page.



KEYBOARD NATIONALITY

English



French



German



Italian



Swedish



USA



Spanish



Belgian





WEDGE



CAPS LOCK

caps lock OFF



caps lock ON



Select the appropriate code to match your keyboard caps lock status.

Note: For **PC Notebook** interface selections, the caps lock status is automatically recognized, therefore this command is not necessary.

INTER-CHARACTER DELAY

delay between characters transmitted to Host

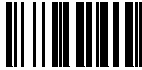

Read 2 numbers from the table where:

00 =	DELAY disabled
01-99 =	DELAY from 1 to 99 milliseconds

INTER-CODE DELAY

delay between codes transmitted to Host



Read 2 numbers from the table where:

00 =	DELAY disabled
01-99 =	DELAY from 1 to 99 seconds

PEN EMULATION

PARAMETERS

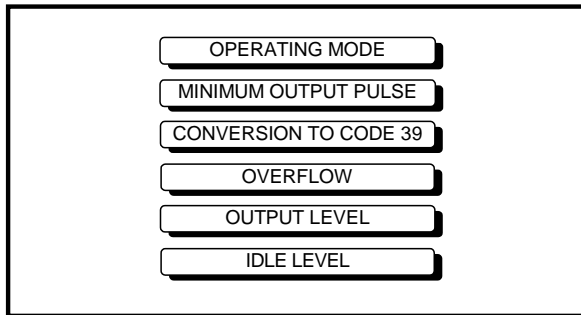

- 1.** Read the **Enter Configuration** code ONCE, available at the top of each page.
- 2.** Read configuration codes from the desired groups.
- 3.** Read the **Exit and Save Configuration** code ONCE, available at the top of each page.

PEN EMULATION

The operating mode parameters are complete commands and do not require reading the Enter and Exit configuration codes.

OPERATING MODE

interpret mode



Interprets commands without sending them to the decoder.

transparent mode



Sends commands to the decoder without interpreting them.



PEN EMULATION



MINIMUM OUTPUT PULSE

high resolution code emulation



low resolution code emulation

See par. 3.2.1 for details.



PEN EMULATION



CONVERSION TO CODE 39

disable



Transmits all codes in their original format.

enable



Converts all codes read into Code 39 format.

OVERFLOW

narrow



medium



wide



See par. 3.2.2 for details.

OUTPUT LEVEL

normal
(white = logic level 0)



inverted
(white = logic level 1)



See par. 3.2.3 for details.

IDLE LEVEL

normal
(black level)



inverted
(white level)



See par. 3.2.3 for details.

DATA FORMAT

NOT FOR PEN INTERFACES

PARAMETERS

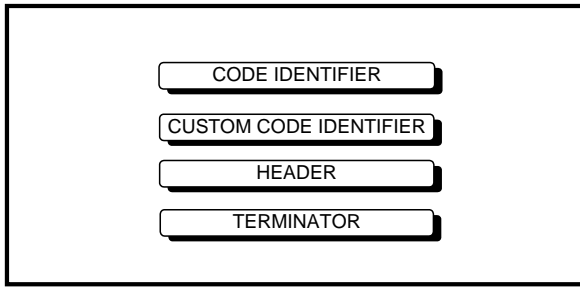

1. Read the **Enter Configuration** code ONCE, available at the top of each page.
2. Read configuration codes from the desired groups.



= Read the code and follow the procedure given

3. Read the **Exit and Save Configuration** code ONCE, available at the top of each page.

DATA FORMAT

CODE IDENTIFIER TABLE			
CODE	AIM STANDARD	DATALOGIC STANDARD	Custom
2/5 interleaved] I y	N	
2/5 industrial] X y	P	
2/5 normal 5 bars] S y	O	
2/5 matrix 3 bars] X y	Q	
EAN 8] E 4	A	
EAN 13] E 0	B	
UPC A] X y	C	
UPC E] X y	D	
EAN 8 with 2 ADD ON] E 5	J	
EAN 8 with 5 ADD ON] E 6	K	
EAN 13 with 2 ADD ON] E 1	L	
EAN 13 with 5 ADD ON] E 2	M	
UPC A with 2 ADD ON] X y	F	
UPC A with 5 ADD ON] X y	G	
UPC E with 2 ADD ON] X y	H	
UPC E with 5 ADD ON] X y	I	
Code 39] A y	V	
Code 39 Full ASCII] A y	W	
CODABAR] F y	R	
ABC CODABAR] X y	S	
Code 128] C 0	T	
EAN 128] C 1	k	
Code 93] G y	U	
CIP/39] X y	Y	
CIP/HR] X y	e	
Code 32] X y	X	

AIM standard identifiers are not defined for all codes: the X identifier is assigned to the code for which the standard is not defined. The y value depends on the selected options (check digit tested or not, check digit tx or not, etc.).

When customizing the Datalogic Standard code identifiers, 1 or 2 identifier characters can be defined for each code type. If only 1 identifier character is required, the second character must be selected as **FF** (disabled).

The code identifier can be singly disabled for any code by simply selecting **FF** as the first identifier character.

Write in the Custom character identifiers in the table above for your records.



DATA FORMAT



CODE IDENTIFIER

disable



Datalogic standard



AIM standard



custom



CUSTOM CODE IDENTIFIER

define custom code identifier(s)



- ① Read the above code.
(Code Identifiers default to Datalogic standard, see table on previous page).
- ② Select the code type from the code table in Appendix B for the identifier you want to change.
- ③ You can define 1 or 2 identifier characters for each code type. If only 1 identifier character is required, the second character must be selected as **FF** (disabled). Read the hexadecimal value corresponding to the character(s) you want to define as identifiers for the code selected in step ②: valid characters are in the range **00-7F**.

EXAMPLE: To define Code 39 Code Identifier = @

define custom code identifier(s)

Read



+ Code 39 + 40 + FF



DATA FORMAT



HEADER

no header



one character header



two character header



three character header



four character header



TERMINATOR

no terminator



one character terminator



two character terminator



three character terminator



four character terminator



After selecting the desired Header/Terminator code, read the character(s) from the HEX table.

EXAMPLE: ^{four character header}
 + 41 + 42 + 43 + 44 = Header **ABCD**

For more details about default values, see par. 3.3.1.

For Terminals see also table in par. 3.3.1, Extended Keyboard To Hex Conversion Table.

POWER SAVE

PARAMETERS

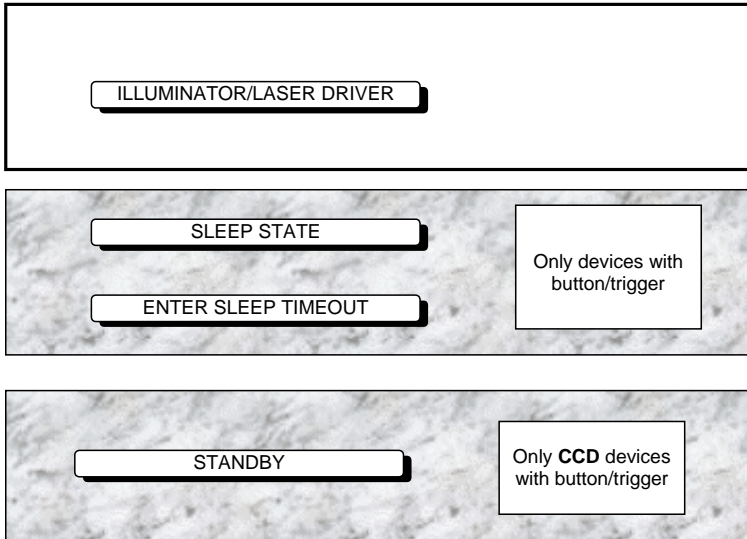

1. Read the **Enter Configuration** code ONCE, available at the top of each page.
2. Read configuration codes from the desired groups.
 = Read the code and follow the procedure given
3. Read the **Exit and Save Configuration** code ONCE, available at the top of each page.



POWER SAVE

ILLUMINATOR/LASER DRIVER

no change before beep



off before beep



See par. 3.4.1 for details.

**ONLY devices with
button/trigger**

SLEEP STATE

enable



disable



See par. 3.4.2 for details.



POWER SAVE

ONLY devices with button/trigger **ENTER SLEEP TIMEOUT**



enter sleep timeout



Read 2 numbers in the range 00-99:

00 = Enter Sleep state immediately

01-99 = corresponds to a max. 9.9 sec. delay before entering the Sleep state.

See par. 3.4.3 for details.

STANDBY

ONLY CCD devices with button/trigger

enable



optimize for low power consumption

disable



optimize for reading speed

See par. 3.4.4 for details.

READING PARAMETERS

PARAMETERS

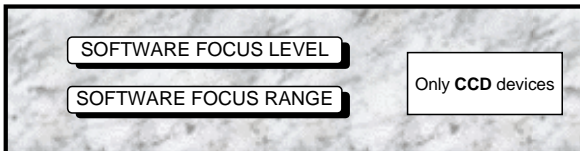
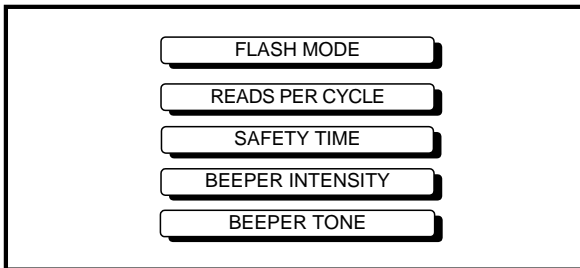
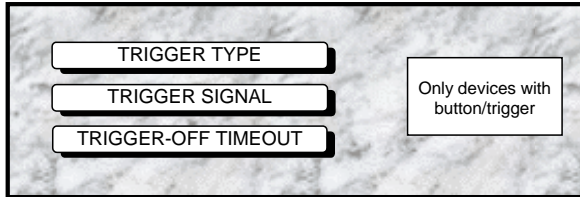

1. Read the **Enter Configuration** code ONCE, available at the top of each page.
2. Read configuration codes from the desired groups.



= Read the code and follow the procedure given

3. Read the **Exit and Save Configuration** code ONCE, available at the top of each page.

Enter configuration



Exit and Save configuration



READING PARAMETERS

**ONLY devices with
button/trigger**

TRIGGER TYPE

hardware trigger



Restores Trigger mode

software trigger



Enables "FLASH" MODE
for trigger version

**ONLY devices with
button/trigger**

TRIGGER SIGNAL

trigger active level



trigger active pulse



See par. 3.5.1 for details.

**ONLY devices with
button/trigger**

TRIGGER-OFF TIMEOUT



trigger-off timeout



Read 2 numbers in the range 00-99:

- 00 = disables the trigger-off timeout
- 01-99 = corresponds to a max. 99 sec. delay after the trigger press to allow the reader to turn off automatically.

See par. 3.5.2 for details.



READING PARAMETERS

FLASH MODE

"FLASH" ON duration



"FLASH" OFF duration



Read 2 numbers in the range 01-99:

01 to 99 = from .1 to 9.9 seconds.

READS PER CYCLE

one read per cycle



multiple reads per cycle



See par. 3.5.3 for details.

SAFETY TIME

safety time



Limits same code consecutive reading.

Read 2 numbers in the range 00-99:

00 = no same code consecutive reading until reader is removed (no decoding) for at least 400 ms.

01 to 99 = timeout from .1 to 9.9 seconds before a consecutive read on same code.

See par. 3.5.4 for details.

Enter configuration



READING PARAMETERS

Exit and Save configuration



BEEPER INTENSITY

beeper off



low intensity



medium intensity



high intensity



BEEPER TONE

tone 1



tone 2



tone 3



tone 4





READING PARAMETERS

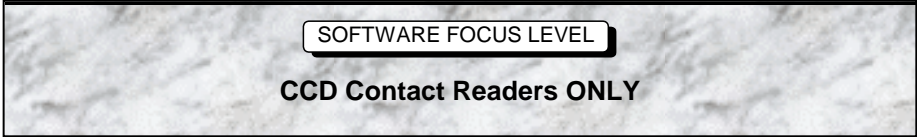

factory focus level



high
resolution
codes

high resolution



med-high resolution



med-low resolution



low resolution



poor
quality
codes



- 1) The factory focus level is sufficient for almost all reading cases.
- 2) Reading time may be improved in your application by setting a fixed focus level. For example in cases where labels are of poor quality or are produced by a pin printer, select low resolution.

Enter configuration



READING PARAMETERS

Exit and Save configuration



SOFTWARE FOCUS RANGE

CCD Long Range Readers ONLY

factory focus range



long range only



- 1) The factory focus range is sufficient for almost all reading cases.
- 2) Reading time may be improved in your application by setting long range only. This selection also eliminates the “double blinking effect”.

DECODING PARAMETERS

PARAMETERS

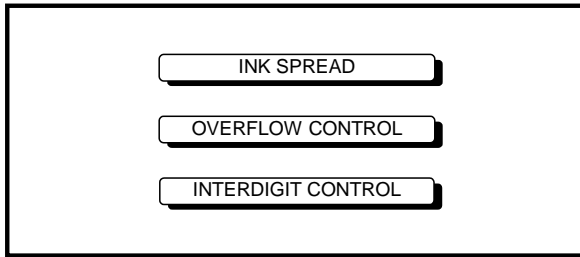

CAUTION

Before changing these parameter values
read the descriptions in par. 3.6.

- 1.** Read the **Enter Configuration** code ONCE, available at the top of each page.
- 2.** Read configuration codes from the desired groups.
- 3.** Read the **Exit and Save Configuration** code ONCE, available at the top of each page.



DECODING PARAMETERS



INK-SPREAD

disable



enable



See par. 3.6.1 for details.

OVERFLOW CONTROL

disable



enable



See par. 3.6.2 for details.



DECODING PARAMETERS



INTERDIGIT CONTROL

disable



enable



See par. 3.6.3 for details.

CODE SELECTION

PARAMETERS

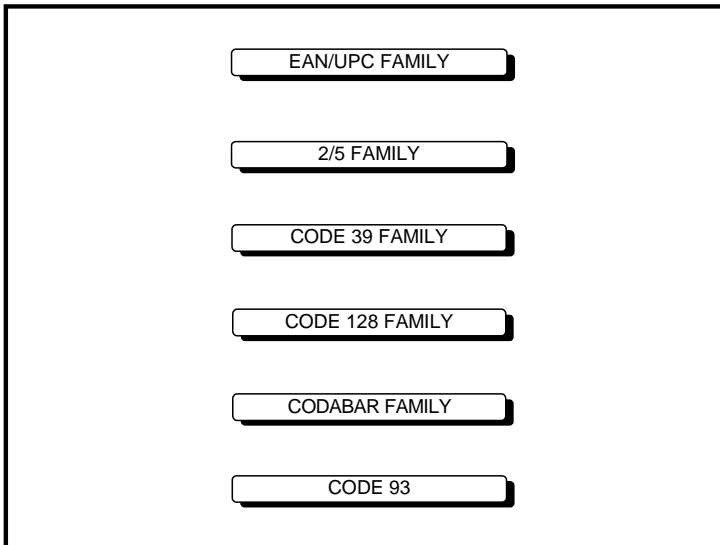

1. Read the **Enter Configuration** code ONCE, available at the top of each page.

2. Read configuration codes from the desired groups.



= Read the code and follow the procedure given

3. Read the **Exit and Save Configuration** code ONCE, available at the top of each page.



CODE SELECTION



DISABLES ALL CODE FAMILIES



NOTE

The reader allows up to 5 code selections. This does not limit the number of CODES enabled to 5, as it depends on the code family:

**SINGLE
SELECTION =**

- **ONE combination code** from the EAN family
- **ONE code** from the 2/5 family
- **ONE or MORE codes** from the Code 128 family
- **ONE or MORE codes** from the Code 39 family
- **ONE or MORE codes** from the Codabar family

Example

5 code selections:

1. **2/5 Interleaved**
2. **2/5 Industrial**
3. Code 128 + EAN 128
4. Code 39 Full ASCII + Code 32
5. **UPC A/UPC E**

In this section all **SINGLE** code selections are **underlined and in bold.**



CODE SELECTION



EAN/UPC FAMILY

disables the family



- ① Read the desired family code

Note:

Since the EAN/UPC without ADD ON code selection is enabled by default, to correctly enable another selection, first disable the family.

EAN 8/EAN 13/UPC A/UPC E with and without ADD ON



WITHOUT ADD ON

EAN 8/EAN 13/UPC A/UPC E



EAN 8/EAN 13



UPC A/UPC E





CODE SELECTION

WITH ADD ON 2 AND 5

EAN 8/EAN 13/UPC A/UPC E



EAN 8/EAN 13



UPC A/UPC E



WITH ADD ON 5 ONLY

EAN 8/EAN 13



UPC A/UPC E



WITH ADD ON 2 ONLY

EAN 8/EAN 13



UPC A/UPC E





CODE SELECTION

EAN/UPC CHECK DIGIT TX SELECTIONS

For each code type in this family you can choose to transmit the check digit or not

CHECK DIGIT TRANSMISSION

EAN 8



EAN 13



UPC A



UPC E



NO CHECK DIGIT TRANSMISSION

EAN 8



EAN 13



UPC A



UPC E





CODE SELECTION



CONVERSION OPTIONS

UPC E to UPC A conversion



UPC E to EAN 13 conversion



UPC A to EAN 13 conversion



EAN 8 to EAN 13 conversion





CODE SELECTION

2/5 FAMILY

disables the family



① Read the desired family code

② Read a check digit selection

Interleaved 2/5



Normal 2/5 (5 Bars)



Industrial 2/5 (IATA)



Matrix 2/5 (3 Bars)



CHECK DIGIT TABLE

no check digit control



check digit control
and transmission



check digit control
without transmission



③ Read 4 numbers for the code length where:

First 2 digits = minimum code length.

Second 2 digits = maximum code length.

The maximum code length is 55 characters. The minimum code length must always be less than or equal to the maximum.

Examples:

0155 = variable from 1 to 55 digits in the code.

1010 = 10 digit code length only.

The pharmaceutical code below is part of the 2/5 family but has no check digit nor code length selections.

Code CIP/HR



French pharmaceutical code



CODE SELECTION

CODE 39 FAMILY

disables the family



① Read the desired family code

② Read a check digit selection

CHECK DIGIT TABLE

no check digit control



check digit control
and transmission



check digit control
without transmission



Standard Code 39



Full ASCII Code 39



The pharmaceutical codes below are part of the Code 39 family but have no check digit selections.

Code CIP39



French pharmaceutical code

Code 32



Italian pharmaceutical code

CODE LENGTH (optional)

The code length selection is valid for the entire Code 39 family

Read the code + 4 numbers for the code length where:

First 2 digits = minimum code length.

Second 2 digits = maximum code length.

set code length



The maximum code length is 32 characters. The minimum code length must always be less than or equal to the maximum.

Examples: **0132** = variable from 1 to 32 digits in the code. **1010** = 10 digit code length only.



CODE SELECTION



CODE 128 FAMILY

disables the family



① Read the desired family code

Code 128



control without transmission
of check digit

EAN 128



control without transmission
of check digit

CODE 93

disables the code



Code 93



control without transmission
of check digit



CODE SELECTION



CODABAR FAMILY

disables the family



- ① Read the desired equality control code ② Read a start/stop transmission selection

Standard Codabar



no start/stop character equality control

START/STOP CHARACTER TRANSMISSION

no transmission



Standard Codabar

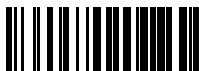

start/stop character equality control

transmission



The Codabar ABC code below uses a fixed start/stop character transmission selection.

Codabar ABC



no start/stop character equality control but transmission.

CODE LENGTH (optional)

The code length selection is valid for the entire Codabar family

Read the code + 4 numbers for the code length where:

First 2 digits = minimum code length.

Second 2 digits = maximum code length.

set code length



The maximum code length is 44 characters. The minimum code length must always be less than or equal to the maximum.

Examples: **0144** = variable from 1 to 44 digits in the code. **1010** = 10 digit code length only.



CODE SELECTION



START/STOP CHARACTER CASE

The start/stop character case selections below are valid for the entire Codabar family:

lower case start/stop characters



upper case start/stop characters



3 REFERENCES

3.1 RS232 PARAMETERS

3.1.1 Handshaking

Hardware handshaking: (RTS/CTS)

The RTS line is activated by the decoder before transmitting a character. Transmission is possible only if the CTS line (controlled by the Host) is active.

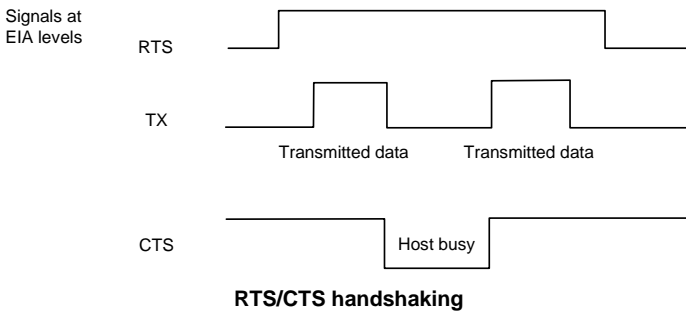

Software handshaking: (XON/XOFF)

During transmission, if the Host sends the XOFF character (13 Hex), the decoder interrupts the transmission with a maximum delay of one character and only resumes when the XON character (11 Hex) is received.

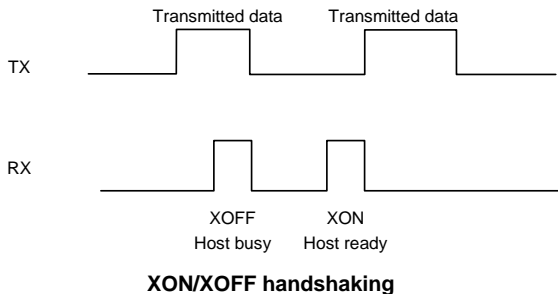

3.1.2 ACK/NACK Protocol

This parameter sets a transmission protocol in which the Host responds to the reader after every code transmitted. The Host sends an ACK character (06 HEX) in the case of good reception or the NACK character (15 HEX) requesting re-transmission, in the case of bad reception.

Selection of the ACK/NACK protocol automatically disables FIFO buffering see par. 3.1.3.

3.1.3 FIFO

This parameter determines whether data (barcodes) are buffered on a First In First Out basis allowing faster data collection in certain cases for example when using slow baud rates and/or HW handshaking.

If the FIFO buffering is enabled, codes are collected and sent out on the serial line in the order of acquisition. Up to 185 characters can be collected (buffer full), after which the reader signals an error and discards any further codes until the transmission is restored.

If the FIFO buffering is disabled, each code must be transmitted before another one can be read.

Selection of FIFO buffering automatically disables ACK/NACK protocol see par. 3.1.2, and Sleep state see par. 3.4.2.

3.1.4 RX Timeout

When the RS232 interface is selected, the Host can be used to configure the device by sending it command strings (see appendix A).

This parameter can be used to automatically end data reception from the Host after the specified period of time.

If no character is received from the Host, after the timeout expires, any incomplete string (any string not terminated by <CR>) is flushed from the device buffer.

3.2 PEN PARAMETERS

3.2.1 Minimum Output Pulse

This parameter sets the duration of the output pulse corresponding to the narrowest element in the barcode. In this way the code resolution is controlled by the signal sent to the decoder, independently of the physical resolution of the code read.

The shortest pulse (200 μ s) corresponds to a high resolution code emulation and therefore a shorter transfer speed to the decoder (for decoders able to work on high resolution codes). Likewise, longer pulses correspond to low resolution code emulation and therefore a longer transfer time to the decoder.

3.2.2 Overflow

This parameter generates a white space before the first bar and after the last bar of the code. The selections are as follows:

narrow = space 10 times the minimum output pulse.
medium = space 20 times the minimum output pulse.
wide = space 30 times the minimum output pulse.

3.2.3 Output and Idle Levels

The following state diagrams describe the different output and idle level combinations for Pen emulation:

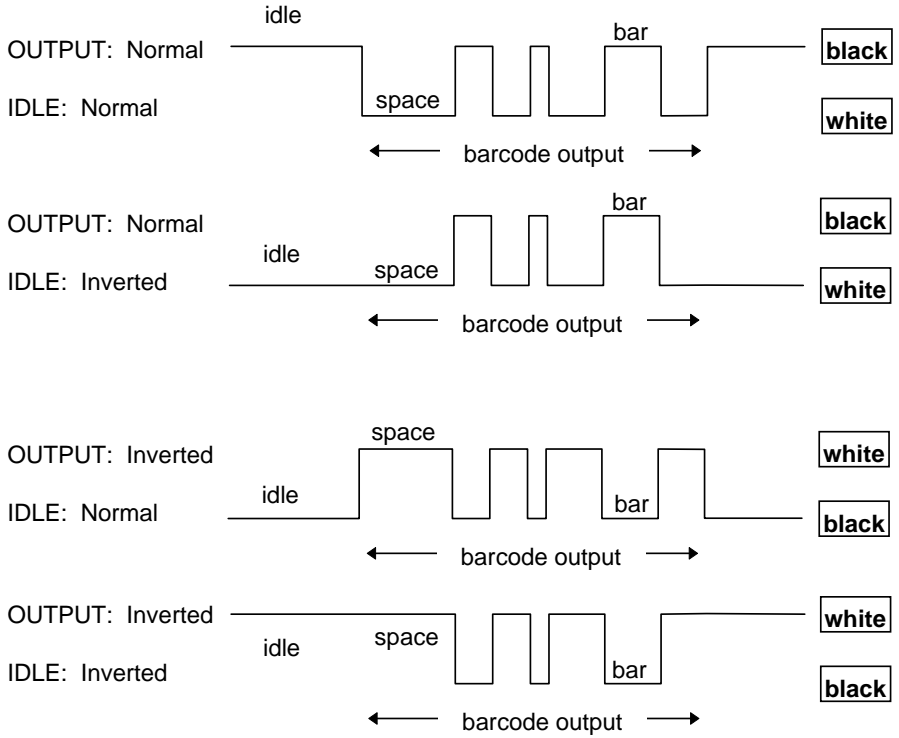

Output and Idle Levels

3.3 DATA FORMAT

3.3.1 Header/Terminator Selection

The header/terminator selection is not effected by the reading of the restore default code. In fact, header and terminator default values depend on the interface selection:

RS232: no header, terminator CR-LF

WEDGE: no header, terminator ENTER

These default values are always restored through the reading of RS232 or WEDGE interface selection code, see the relative Quick Reference Manual.

For the WEDGE interface, the following extended keyboard values can also be configured:

EXTENDED KEYBOARD TO HEX CONVERSION TABLE				
HEX	IBM AT	IBM 3153	IBM XT	IBM 31xx, 32xx, 34xx, 37xx
83		ENTER	ENTER	FIELD EXIT
84		TAB	TAB	TAB
85		F1	F1	F1
86		F2	F2	F2
87		F3	F3	F3
88		F4	F4	F4
89		F5	F5	F5
8A		F6	F6	F6
8B		F7	F7	F7
8C		F8	F8	F8
8D		F9	F9	F9
8E		F10	F10	F10
8F		F11	ESC	F11
90		F12	BACKSPACE	F12
91		HOME	HOME	ENTER
92		END	END	RESET
93		PG UP	PG UP	INSERT
94		PG DOWN	PG DOWN	DELETE
95		↑	↑	FIELD -
96		↓	↓	FIELD +
97		←	←	ENTER (Paddle)
98		→	→	PRINT
99		ESC	ESC	
9A		CTRL (Right)	CTRL (Right)	

3.4 POWER SAVE

3.4.1 Illuminator/Laser driver

To reduce maximum power consumption, this command assures that the **Illuminator** (for CCD devices), and the **beeper** are not on simultaneously.

For scanners the **Laser** and the **beeper** are not on simultaneously.

3.4.2 Sleep state (*only devices with button/trigger*)

This mode allows the μP in the reader to enter a "Sleep" state for minimum power consumption. This command is only valid for readers with button/trigger when hardware trigger type is selected.

Before entering Sleep mode, the following are verified:

- no commands coming from Host
- no data being transmitted to Host
- Enter Sleep Timeout ended (see par. 3.4.3)

To exit Sleep mode press the trigger.

Enabling the Sleep state automatically enables Standby mode for CCD devices, see par. 3.4.4, and disables FIFO, see par. 3.1.3.

3.4.3 Enter sleep timeout

For readers that have the Sleep state enabled, this timeout determines when the reader will enter this state.

3.4.4 Standby (*only CCD devices with button/trigger*)

If this command is enabled, part of the CCD circuitry shuts down (Standby), in order to optimize low power consumption when not reading. When the trigger is pressed this circuitry powers up. This mode causes a minor delay before the reader is ready, ranging from a few milliseconds to a few tenths of a second (depending on the reader).

Disabling Standby mode automatically disables the Sleep state, see par. 3.4.2.

3.5 READING PARAMETERS

3.5.1 Trigger signal

Trigger signal is useful to determine the modality of the reader ON state for readers with trigger when hardware trigger is selected:

- trigger level: the reader goes ON when the trigger is pressed and goes OFF when it is released
- trigger pulse: the reader goes ON at the first trigger press and goes OFF only at a second press

3.5.2 Trigger-Off Timeout

The timeout is useful for readers with trigger when hardware trigger type is selected.

When timeout is selected, the reader which isn't decoding turns OFF automatically after the desired period of time.

3.5.3 Reads per Cycle

In general, a **reading cycle** corresponds to the ON + OFF times of a device. The resulting effects of this parameter on code reading depend on other related configuration conditions. Here are the definitions of ON and OFF times.

- For readers which operate in FLASH MODE (either readers without button/trigger, or readers with trigger using the *software trigger* parameter), a reading cycle corresponds to the *flash on* + *flash off* times. Code reading takes place during the *flash on* time.
- For readers with button/trigger and using the *hardware trigger* parameter, a reading cycle corresponds to a trigger press (ON) + one of the following OFF conditions:
 - trigger release (for *trigger active level*)
 - a second trigger press (for *trigger active pulse*)
 - trigger-off timeout* (see par. 3.5.2).

When **one read per cycle** is selected, the device decodes only one code during the ON period and immediately turns OFF the reader. It is only possible to read another code when the next ON time occurs.

In **multiple reads per cycle**, the device decodes a code during the ON period. The *flash on* or the *trigger-off timeout* period is immediately reset after each read and therefore extended. If another code is decoded before the reset *flash on* or *timeout* period expires, the *flash on* or *timeout* is again reset and the effect is that the device remains ON, decoding codes until the *flash on* or *timeout* period expires.

The Safety Time parameter should be used in this case to avoid unwanted multiple reading of the same code, see par. 3.5.4.

3.5.4 Safety Time

Safety time prevents the device from immediately decoding the same code more than once. Same code consecutive reading can be disabled requiring the reader to be removed from the code (no decoding) for at least 400 ms, or a timeout can be set up to 9.9 seconds before the decoder will accept the same code. Reading is immediate if the code changes.

3.6 DECODING PARAMETERS

CAUTION

These parameters are intended to enhance the decoding capability of the reader for particular applications. Used incorrectly, they can degrade the reading performance or increase the possibility of a decoding error.

3.6.1 Ink-spread

The ink-spread parameter allows the decoding of codes which are not perfectly printed because the page texture tends to absorb the ink.

3.6.2 Overflow control

The overflow control parameter can be disabled when decoding codes printed on small surfaces, which don't allow the use of an overflow space.

This command does not effect code families 2/5, Code 128 and Code 93.





3.6.3 Interdigit control

The interdigit control parameter verifies the interdigit spacing for code families Code 39 and Codabar.

3.7 CONFIGURATION EDITING COMMANDS

The barcode reading configuration method described in each section of chapter 2 of this manual is the most common way to configure your device.

However, additional editing commands are available and are described in this paragraph.



Command	Description
 \$+	Enter configuration environment
 \$%	Backspace - cancel an incomplete configuration sequence without exiting configuration environment
 \$/	Cancel all modifications without exiting configuration environment
 \$-	Exit and Save configuration in EEPROM

The Exit and Save command \$- can be replaced by \$) which exits saving the configuration only to RAM (without saving in EEPROM). The new configuration is valid as long as the decoder remains powered.

In this case, the following commands save in EEPROM, either the modified configuration in RAM, or the previously saved EEPROM configuration; then exit the configuration environment.

Command	Description
 \$)	End of modifications (Exit saving to RAM without saving in EEPROM)
<td>Restore last configuration saved in EEPROM</td>	Restore last configuration saved in EEPROM

The following two commands carry out their specific function and then exit the configuration environment.

Command	Description
 \$+\${*}	Restore system default configuration (see the relative Quick Reference Manual for default settings)
 \$+!\$"	Transmit the Software release

4 TROUBLESHOOTING

If your device does not work properly after configuration, read the code corresponding to your device type and then follow the regular programming procedure in the Quick Reference manual.

CCD Contact Readers



CCD Long Range Readers



Laser Scanners



APPENDIX A HOST CONFIGURATION STRINGS

In this section we provide a description of how to modify the device configuration using serial strings sent from the Host.

This method requires the RS232 interface.

The device configuration can be changed by receiving commands from the Host through the serial interface. When this method is used, the programming sequence format is the following:

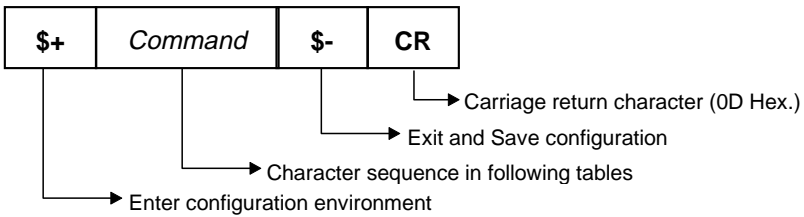

Example:

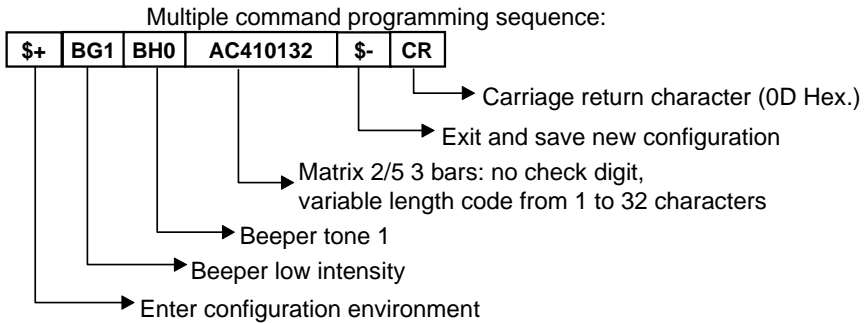

Each configuration parameter setting removes the condition previously active for that parameter.

NOTE

The device buffer can contain a maximum of 60 characters. If your programming string goes over this value, you must split it into separate groups and send each group after a delay of at least 3 seconds to give the reader time to empty the buffer and interpret the commands.

SERIAL CONFIGURATION STRINGS

ENTER/EXIT CONFIGURATION COMMANDS	
DESCRIPTION	STRING
Enter Configuration	\$+
Exit and Save Configuration	\$-
Restore Default	\$*
Transmit Software Release (not for PEN emulation)	\$!

INTERFACE SELECTION		
DESCRIPTION	STRING	
RS232 interface	CP0	
WEDGE	for IBM AT	CP500
	for IBM Terminals: 31xx, 32xx, 34xx, 37xx; make-break keyboard	CP501
	for IBM Terminals: 31xx, 32xx, 34xx, 37xx; make only keyboard	CP502
	for IBM XT	CP503
	for IBM Terminal 3153	CP504
	for IBM PC Notebook * only if selectable from Quick Reference	CP505
	for IBM SURE1	CP506
PEN emulation interface	CP6	

RS232		
DESCRIPTION	STRING	
Baud rate	150	CD0
	300	CD1
	600	CD2
	1200	CD3
	2400	CD4
	4800	CD5
	9600	CD6
	19200	CD7
Parity	none	CC0
	even	CC1
	odd	CC2
Data bits	7	CA0
	8	CA1
	9	CA2
Stop bits	1	CB0
	2	CB1
Handshaking	disable	CE0
	RTS/CTS	CE1
	XON/XOFF	CE2

RS232 (continued)		
ACK/NACK Protocol	disable	CF0
	enable	CF3
FIFO:	disable	EC0
	enable	EC1
Inter-character delay (<i>ms</i>)		CK00 - CK99
RX Timeout (<i>100 ms</i>)		CL00 - CL99

WEDGE		
DESCRIPTION		STRING
Keyboard Type for	typewriter	FK0
IBM Terminals 31xx, 32xx, 34xx, 37xx	advanced	FK1
Keyboard nationality	Belgian	FJ7
	English	FJ4
	French	FJ2
	German	FJ3
	Italian	FJ1
	Spanish	FJ6
	Swedish	FJ5
	USA	FJ0
Caps Lock	caps Lock ON	FE1
	caps Lock OFF	FE0
Delays	inter-character (<i>ms</i>)	CK00 - CK99
	inter-code (<i>s</i>)	FG00 - FG99

PEN		
DESCRIPTION		STRING
Operating mode	interpret (does not require \$+ or \$-)	\$]
	transparent (does not require \$+ or \$-)	\$[
Minimum output pulse	200µs	DG0
	400µs	DG1
	600µs	DG2
	800µs	DG3
	1 ms	DG4
	1.2 ms	DG5
Conversion to Code 39	disable	DA0
	enable	DA1
Output level	normal	DD0
	inverted	DD1
Idle level	normal	DE0
	inverted	DE1
Overflow	narrow overflow	DH0
	medium overflow	DH1
	wide overflow	DH2

DATA FORMAT		
<i>NOT FOR PEN EMULATION INTERFACES</i>		
DESCRIPTION		STRING
Code Identifier	disable	EB0
	Datalogic standard	EB1
	AIM standard	EB2
	Custom	EB3
Custom Code Identifier		EHabc
Headers	no header	EA00
	one character	EA01x
	two characters	EA02xx
	three characters	EA03xxx
	four characters	EA04$xxxx$
Terminators	no terminator	EA10
	one character	EA11x
	two characters	EA12xx
	three characters	EA13xxx
	four characters	EA14$xxxx$

a = ASCII character.
b, c, x = HEX values representing an ASCII character.

a = ASCII character of the DATALOGIC STANDARD Code Identifier from the table in the Data Format group.

b = Hex value of the first Custom Code Identifier character from **00** to **7F**;
FF = disable Code Identifier

c = Hex value of the second Custom Code Identifier character from **00** to **7F**;
FF = disable second character of Custom Code Identifier

x = for RS232: Hex value from **00** to **7F**

x = for WEDGE: Hex value from **00** to **99**

POWER SAVE		
DESCRIPTION		STRING
Illuminator/Laser Driver	no change before beep	BN0
	off before beep	BN1
Sleep State (Only CCD devices with button/trigger)	disable	BQ0
	enable	BQ1
Enter Sleep Timeout (100 ms) (Only CCD devices with button/trigger)		BR00-99
Standby (Only CCD devices with button/trigger)	enable	BM0
	disable	BM1

READING PARAMETERS		
DESCRIPTION		STRING
Trigger Type (Only devices with button/trigger)	hardware	BK1
	software	BK0
Trigger Signal (Only devices with button/trigger)	level	BA0
	pulse	BA1
Trigger-off Timeout (s) (Only devices with button/trigger)		BD00 - BD99
FLASH ON (100 ms)		BB001 - BB099
FLASH OFF (100 ms)		BB101 - BB199
Reads per Cycle	one read	BC0
	multiple reads	BC1
Safety Time (100 ms)		BE00 - BE99
Beeper Intensity	beeper off	BG0
	low intensity	BG1
	medium intensity	BG2
	high intensity	BG3
Beeper Tone	tone 1	BH0
	tone 2	BH1
	tone 3	BH2
	tone 4	BH3
Software Focus level (CCD Contact Readers ONLY)	factory focus level	BL0
	high resolution codes	BL1
	med-high resolution codes	BL2
	med-low resolution codes	BL3
Software Focus range (CCD Long Range Readers ONLY)	factory focus range	BS0
	long range only	BS1

DECODING PARAMETERS		
DESCRIPTION		STRING
Ink-spread	disable	AX0
	enable	AX1
Overflow control	disable	AW1
	enable	AW0
Interdigit control	disable	AV0
	enable	AV1

CODE SELECTION			STRING
DESCRIPTION			
DISABLE ALL FAMILY CODES			AZ0
EAN/UPC	disable EAN/UPC family		AA0
	EAN 8/EAN 13/UPC A/UPC E	without ADD ON	AA1
		with ADD ON	AA5
		with and without ADD ON	AA8
	EAN 8/EAN 13	without ADD ON	AA3
		with ADD ON 2 ONLY	AAK
		with ADD ON 5 ONLY	AAL
		with ADD ON 2 AND 5	AA6
	UPC A/UPC E	without ADD ON	AA4
		with ADD ON 2 ONLY	AAM
		with ADD ON 5 ONLY	AAN
		with ADD ON 2 AND 5	AA7
	EAN 8 check digit transmission	disable	AAG0
		enable	AAG1
	EAN 13 check digit transmission	disable	AAH0
		enable	AAH1
	UPC A check digit transmission	disable	AAI0
		enable	AAI1
	UPC E check digit transmission	disable	AAJ0
		enable	AAJ1
conversions	UPC E to UPC A	AAA	
	UPC E to EAN 13	AAB	
	UPC A to EAN 13	AAC	
	EAN 8 to EAN 13	AAD	
Code 39	disable Code 39 family		AB0
	Standard	no check digit control	AB11
		check digit control and transmission	AB12
		check digit control without transmission	AB13
	Full ASCII	no check digit control	AB21
		check digit control and transmission	AB22
		check digit control without transmission	AB23
	CIP 39		AB3
	Code 32		AB4
	code length		AB*xxxx

xxxx = ASCII numbers that define the code length where:

- First 2 digits = minimum acceptable code length.
- Second 2 digits = maximum acceptable code length.

The minimum code length must always be less than or equal to the maximum.

Examples:

0132 = variable length from 1 to 32 digits in the code.

1010 = 10 digit code length only.

The maximum code lengths are:	
Code 39	32 characters
Codabar	44 characters
2/5	55 characters

CODE SELECTION (continued)			
DESCRIPTION		STRING	
2/5	disable Code 2/5 family		AC0
	Interleaved 2/5	no check digit control	AC11xxxx
		check digit control and transmission	AC12xxxx
		check digit control without transmission	AC13xxxx
	Normal 2/5 5 bars	no check digit control	AC21xxxx
		check digit control and transmission	AC22xxxx
		check digit control without transmission	AC23xxxx
	Industrial 2/5 (IATA)	no check digit control	AC31xxxx
		check digit control and transmission	AC32xxxx
		check digit control without transmission	AC33xxxx
	Matrix 2/5 3 bars	no check digit control	AC41xxxx
		check digit control and transmission	AC42xxxx
check digit control without transmission		AC43xxxx	
CIP/HR		AC5	
Codabar	disable Codabar family		AD0
	Standard	no start/stop character equality control nor transmission	AD111
		no start/stop character equality control but transmission	AD112
		start/stop character equality control but no transmission	AD121
		start/stop character equality control and transmission	AD122
	ABC CODABAR	no start/stop character equality control but transmission	AD212
	code length		AD*xxxx
	start/stop character case	lower case	ADA0
upper case		ADA1	
Code 128	disable Code 128 family		A10
	enable Code 128 - control without transmission of check digit		A11
	enable EAN 128 - control without transmission of check digit		A121
Code 93	disable Code 93 family		AK0
	enable Code 93 - control without transmission of check digit		AK1

xxxx = ASCII numbers that define the code length where:

- First 2 digits = minimum acceptable code length.
- Second 2 digits = maximum acceptable code length.

The minimum code length must always be less than or equal to the maximum.

Examples:

0132 = variable length from 1 to 32 digits in the code.

1010 = 10 digit code length only.

The maximum code lengths are:	
Code 39	32 characters
Codabar	44 characters
2/5	55 characters

This page is intentionally left blank.

APPENDIX B CODE IDENTIFIER TABLE

2/5 Interleaved



2/5 Industrial



2/5 normal 5 bars



2/5 matrix 3 bars



EAN 8



EAN 13



UPC A



UPC E



EAN 8 with 2 ADD ON



EAN 8 with 5 ADD ON



EAN 13 with 2 ADD ON



EAN 13 with 5 ADD ON



UPC A with 2 ADD ON



UPC A with 5 ADD ON



UPC E with 2 ADD ON



UPC E with 5 ADD ON



Code 39



Code 39 Full ASCII



CODABAR



ABC CODABAR



Code 128



EAN 128



Code 93



CIP/39



CIP/HR



Code 32



APPENDIX C HEX AND NUMERIC TABLES

**OPEN THIS PAGE TO READ THE DESIRED
HEX AND NUMERIC SELECTIONS**

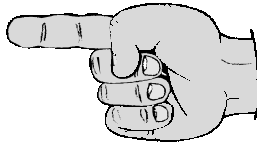

HEX TABLE

CHARACTER TO HEX CONVERSION TABLE					
char	hex	char	hex	char	hex
NUL	00	*	2A	U	55
SOH	01	+	2B	V	56
STX	02	,	2C	W	57
ETX	03	-	2D	X	58
EOT	04	.	2E	Y	59
ENQ	05	/	2F	Z	5A
ACK	06	0	30	[5B
BEL	07	1	31	\	5C
BS	08	2	32]	5D
HT	09	3	33	^	5E
LF	0A	4	34	~	5F
VT	0B	5	35	a	60
FF	0C	6	36	b	61
CR	0D	7	37	c	62
SO	0E	8	38	d	63
SI	0F	9	39	e	64
DLE	10	:	3A	f	65
DC1	11	;	3B	g	66
DC2	12	<	3C	h	67
DC3	13	=	3D	i	68
DC4	14	>	3E	j	69
NAK	15	?	3F	k	6A
SYN	16	@	40	l	6B
ETB	17	A	41	m	6C
CAN	18	B	42	n	6D
EM	19	C	43	o	6E
SUB	1A	D	44	p	6F
ESC	1B	E	45	q	70
FS	1C	F	46	r	71
GS	1D	G	47	s	72
RS	1E	H	48	t	73
US	1F	I	49	u	74
SPACE	20	J	4A	v	75
!	21	K	4B	w	76
"	22	L	4C	x	77
#	23	M	4D	y	78
\$	24	N	4E	z	79
%	25	O	4F	{	7A
&	26	P	50		7B
'	27	Q	51	}	7C
(28	R	52	~	7D
)	29	S	53	DEL	7E
		T	54		7F



0



2



4



6



8



A



C



E

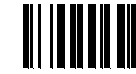

1



3



5



7



9



B



D



F

Backspace



Cancels an incomplete configuration sequence

SW 4.00



90ACC1710